



Yuasa Fiche de données techniques

Yuasa YTX14-BS - Maintenance Free batterie

Performance

Tension	12V
Capacity (10-hour)	12Ah
Capacité (20 heures)	12.6Ah
CCA @ -18°C	200A

Dimensions (±2mm)

Longueur	150mm
Largeur	87mm
Hauteur	145mm

Poids & Mesures

Poids moyen avec acide	4.6kg
Volume d'acide	0.69l

Mounting Angle

Angle A	30°
Angle B	20°
Angle C	20°

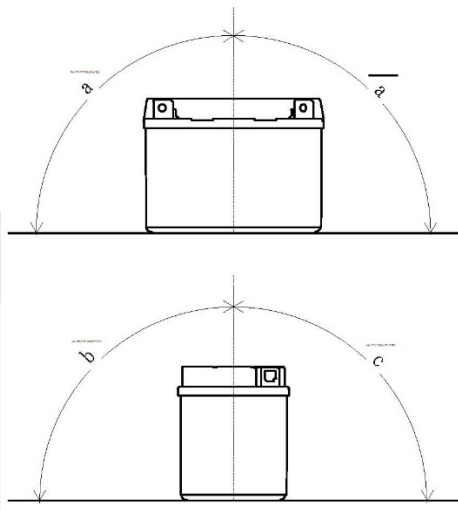

Technologie

Séparateur AGM

Schéma de montage des éléments

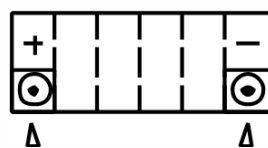

Type de bornes - 5



Date de publication: 17/11/2016 - E&OE



Yuasa Technical Data Sheet

Yuasa YTX14-BS - Maintenance Free Battery

Performance

Voltage	12V
Capacity (10-hour)	12Ah
Capacity (20-hour)	12.6Ah
CCA @ -18°C	200A

Dimensions (±2mm)

Length	150mm
Width	87mm
Height	145mm

Weights & Measures

Mean Weight with Acid	4.6kg
Acid Volume	0.69l

Mounting Angle

Angle A	30°
Angle B	20°
Angle C	20°

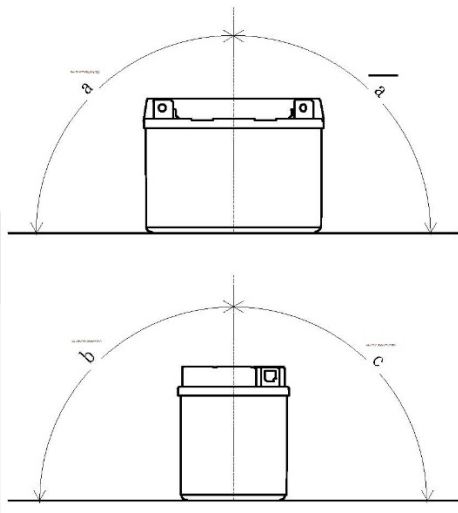

Technology

Separator AGM

Cell Assembly Layout

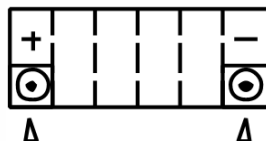

Terminal Type - 5



Data Sheet generated on 17/11/2016 - E&OE