



AGM LEAD ACID BATTERY

S 12V-33Ah

AGM
STANDARD

MAIN INFORMATION / INFORMATIONS GÉNÉRALES

BRAND / MARQUE	NX
TECHNOLOGY / TECHNOLOGIE	AGM Lead acid
NOMINAL VOLTAGE / TENSION NOMINALE	12V
NOMINAL CAPACITY / CAPACITÉ NOMINALE	33Ah (20hr)
DIMENSIONS (± 2 mm) / DIMENSIONS (± 2 mm)	
• Length / Longueur	195±2mm (7.68 inches)
• Width / Largeur	130±2mm (5.12 inches)
• Height / Hauteur	164±2mm (6.46 inches)
• Total height with auto terminal adaptor / Hauteur totale (avec borne auto)	178±2mm (7.01 inches)
WEIGHT (± 2 %) / POIDS (± 2 %)	Approx 10,5kg (23,2 lbs)
TERMINAL / TYPE DE COSSES	T6 + Auto terminal adaptor
CASING / TYPE DE BAC	UL94 HB (Standard ABS)
COLOUR / COULEUR DE BAC	Black top and black case



TECHNICAL INFORMATION / INFORMATIONS TECHNIQUES

CAPACITY / CAPACITÉ	33.0 AH/1.65A (20hr, 1.80V/cell, 25°C/77°F) 30.7 AH/3.07A (10hr, 1.80V/cell, 25°C/77°F) 28.1 AH/5.61A (5hr, 1.75V/cell, 25°C/77°F) 25.3 AH/8.42A (3hr, 1.75V/cell, 25°C/77°F) 20.7 AH/20.7A (1hr, 1.60V/cell, 25°C/77°F)
MAX DISCHARGE CURRENT / COURANT DE DÉCHARGE	495A (5s)
INTERNAL RESISTANCE / RÉSISTANCE INTERNE	Approx 12mΩ
OPERATING TEMPERATURE RANGE / PLAGES DE TEMPÉRATURE	
• DISCHARGING / DÉCHARGE	-15~ 50 °C (5 ~122 °F)
• CHARGING / CHARGE	0 ~40 °C (32~ 104 °F)
• STORAGE / STOCKAGE	-15~ 40°C(5 ~104 °F)
NOMINAL OPERATING TEMPERATURE / TEMPÉRATURE D'UTILISATION	25± 3°C (77± 5° F)
CAPACITY VS TEMPERATURE / CAPACITÉ SELON LA TEMPÉRATURE	40°C (104 F) 103% 25°C (77 F) 100% 0°C (32 F) 86%

■ T6 + Auto terminal adaptor
Unité : mm / Unit: inches

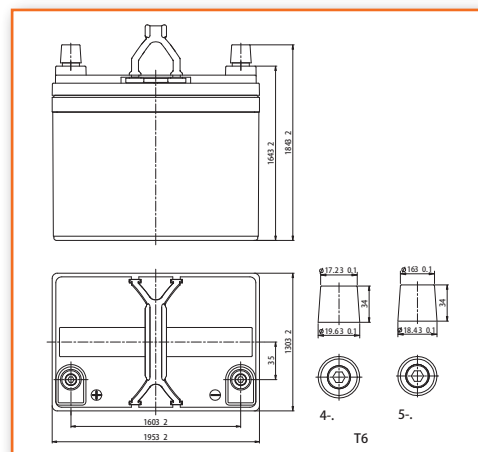
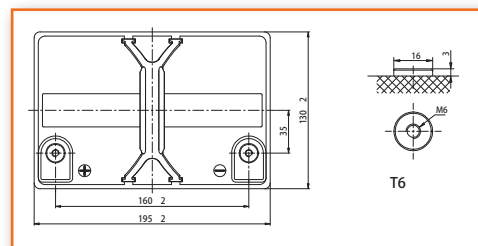

APPLICATIONS

All purpose / Tout usage	Aircraft signal / Signal d'avion
UPS / Onduleur	Electronic devices and equipment / Appareils et équipements électroniques
Emergency light / Éclairage de secours	Emergency backup / Alimentation de secours
Railway signal / Signalisation ferroviaire	Power supply / Réserve d'énergie
Alarm and security system / Alarme et sécurité	

TMD 1 Description, classe : UN 2800 – accumulateurs inversables remplis d'électrolyte liquide, 8, none, (E)

ADR : Not regulated

IMDG : Not regulated

IATA : Exempt

Procédure TMD PROC 2 : UN 2800

www.enix-energies.com • Date: 2016/10/18



CONSTANT CURRENT DISCHARGE (AMPERES) AT 25°C
TABLE DE DÉCHARGE À COURANT ET PUISSANCE CONSTANTS (A) À 25°C

F.V/Time	5min	10min	15min	20min	30min	45min	1h	2h	3h	4h	5h	6h	8h	10h	20h
1.85V/cell	62.8	48.3	40.0	34.6	26.7	19.69	16.6	9.81	7.68	6.24	5.09	4.42	3.56	2.98	1.63
1.80V/cell	84.4	61.7	48.3	40.9	31.5	22.9	18.6	10.7	8.26	6.67	5.46	4.74	3.78	3.07	1.65
1.75V/cell	95.1	67.8	52.8	44.0	32.7	23.8	19.4	11.1	8.42	6.81	5.61	4.87	3.84	3.15	1.67
1.70V/cell	104.7	73.9	56.3	46.2	34.1	24.7	20.1	11.4	8.65	7.00	5.75	4.97	3.90	3.21	1.70
1.65V/cell	115.5	79.7	59.9	49.1	35.9	25.3	20.5	11.6	9.02	7.24	5.91	5.08	3.96	3.28	1.72
1.60V/cell	127.4	86.5	64.1	52.3	38.0	26.4	20.7	12.0	9.29	7.46	6.11	5.19	4.00	3.32	1.73

CONSTANT POWER DISCHARGE (WATTS) AT 25°C
DÉCHARGE À PUISSANCE CONSTANTE (WATTS) À 25°C

F.V/Time	5min	10min	15min	20min	30min	45min	1h	2h	3h	4h	5h	6h	8h	10h	20h
1.85V/cell	114.9	89.1	74.6	65.2	50.9	37.8	32.0	19.1	15.0	12.2	10.0	8.69	7.03	5.89	3.24
1.80V/cell	152.6	112.6	88.9	75.9	59.2	43.7	35.7	20.7	16.0	13.0	10.7	9.28	7.44	6.06	3.26
1.75V/cell	168.4	121.7	95.9	80.9	60.9	44.9	37.1	21.3	16.2	13.2	10.9	9.50	7.55	6.22	3.29
1.70V/cell	180.3	129.6	101.0	84.3	63.1	46.5	38.2	21.8	16.7	13.5	11.2	9.69	7.65	6.34	3.35
1.65V/cell	196.0	138.6	106.6	88.9	66.0	47.2	38.8	22.0	17.3	13.9	11.4	9.87	7.75	6.46	3.39
1.60V/cell	211.2	147.1	112.1	93.7	69.2	49.0	39.0	22.9	17.7	14.3	11.8	10.0	7.81	6.52	3.40

CARACTÉRISTIQUES DE DÉCHARGE / DISCHARGE CHARACTERISTICS

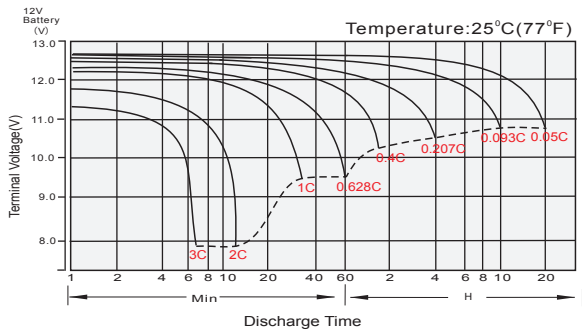

COURANT DE DÉCHARGE ET TEMPS DE DÉCHARGE / FLOAT CHARGING CHARACTERISTICS

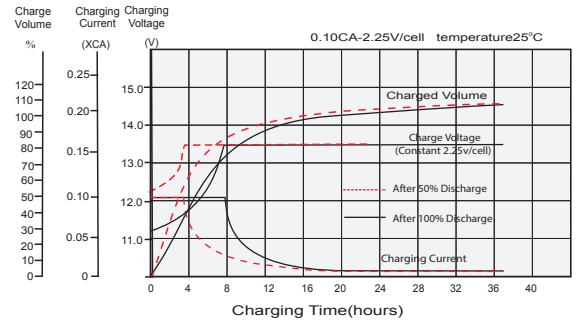

EFFET DE LA TEMPÉRATURE SUR LA BATTERIE / TEMPERATURE EFFECTS IN RELATION TO BATTERY CAPACITY

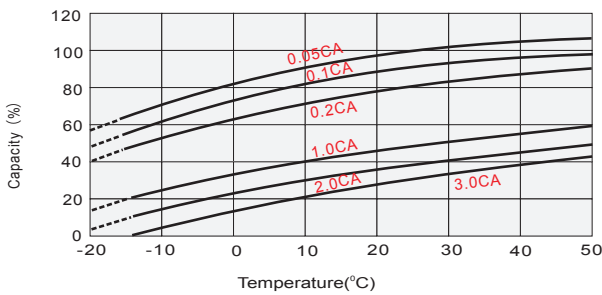

EFFET DE LA TEMPÉRATURE SUR LA DURÉE DE VIE EN FLOATING / EFFECT OF TEMPERATURE ON LONG TERM FLOAT LIFE

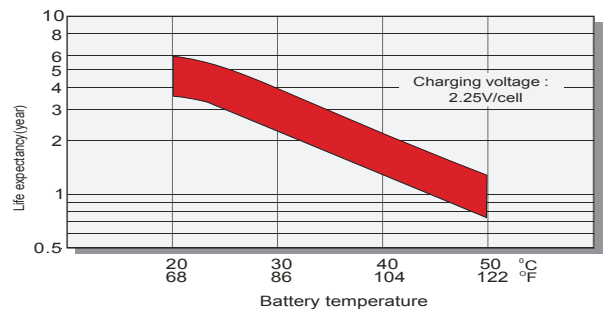

CYCLE DE VIE EN FONCTION DE LA PROFONDEUR DE LA DÉCHARGE / CYCLE LIFE IN RELATION TO DEPTH OF DISCHARGE

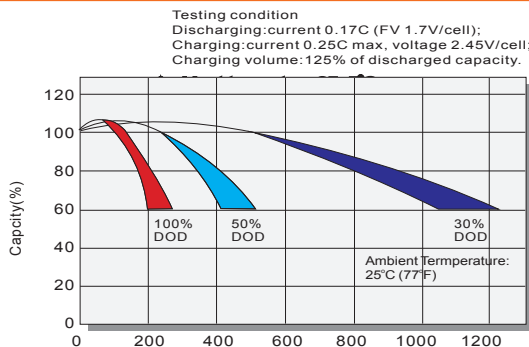

RELATION ENTRE LA CAPACITÉ ET LE TEMPS DE STOCKAGE / SELF DISCHARGE CHARACTERISTICS

