

> iXtra – long term high performance

Performance Data

(Typical values for batteries stored at +25 °C for one year)

System	Lithium Thionyl Chloride
Nominal voltage	3.6 V
Nominal capacity	19 Ah
Nominal current	4 mA
Max. continuous discharge current	340 mA
Pulse current capability	600 mA
Anode surface area	45 cm ²
Lithium content	5 g
Weight	93 g
Volume	51 cm ³
Temperature range	-55 °C ... +85 °C



Typical Discharge Curves at +25 °C

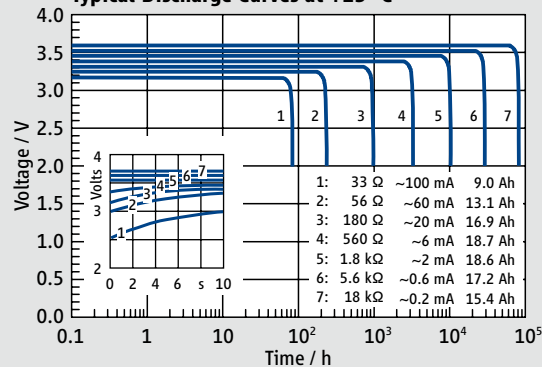

Available Capacity

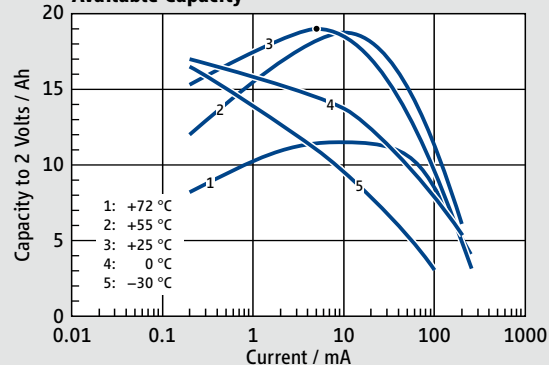

Operating Voltage

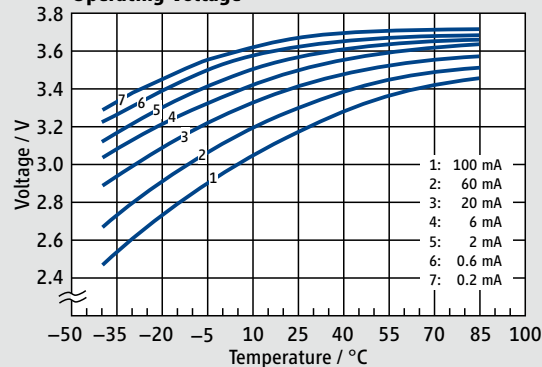

Voltage Response at +25 °C, Pulse: 60 mA

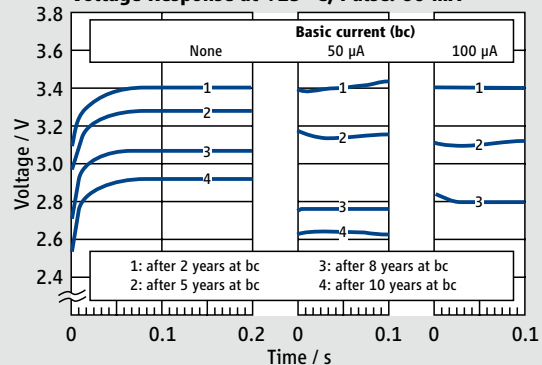

SL-2780/S

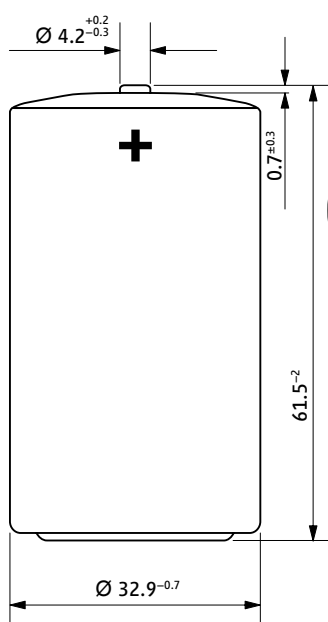

SL-2780/T

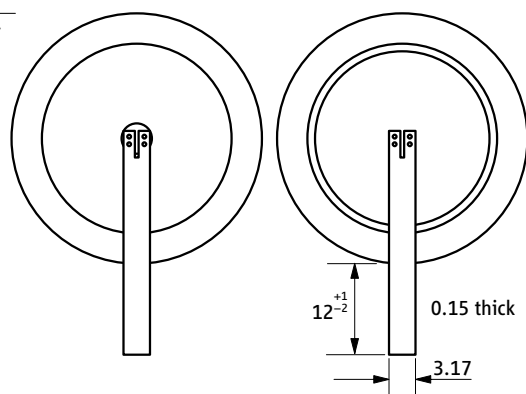

SL-2780/P

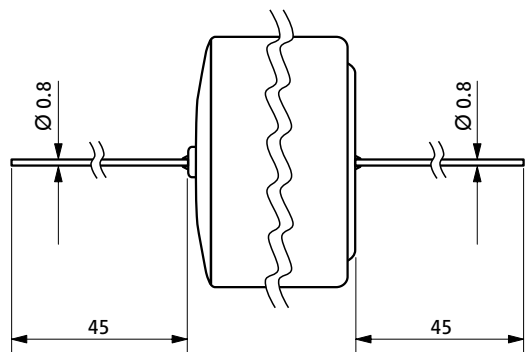

Available Terminations

SL-2780/S	Standard	11 2 17801 00
SL-2780/T	Tags	11 2 17802 00
SL-2780/P	Pins	11 2 17803 00

Catalogue No.

WARNING: Fire, explosion, and severe burn hazard. Do not recharge, disassemble, heat above 100 °C, incinerate, or expose contents to water.